



# Installation instructions, accessories

Volvo Car Corporation Gothenburg, Sweden

Instruction No	Version	Part. No.
31435860	1.0	31435858, 39842581, 39842582

## Sill molding, illuminated, front

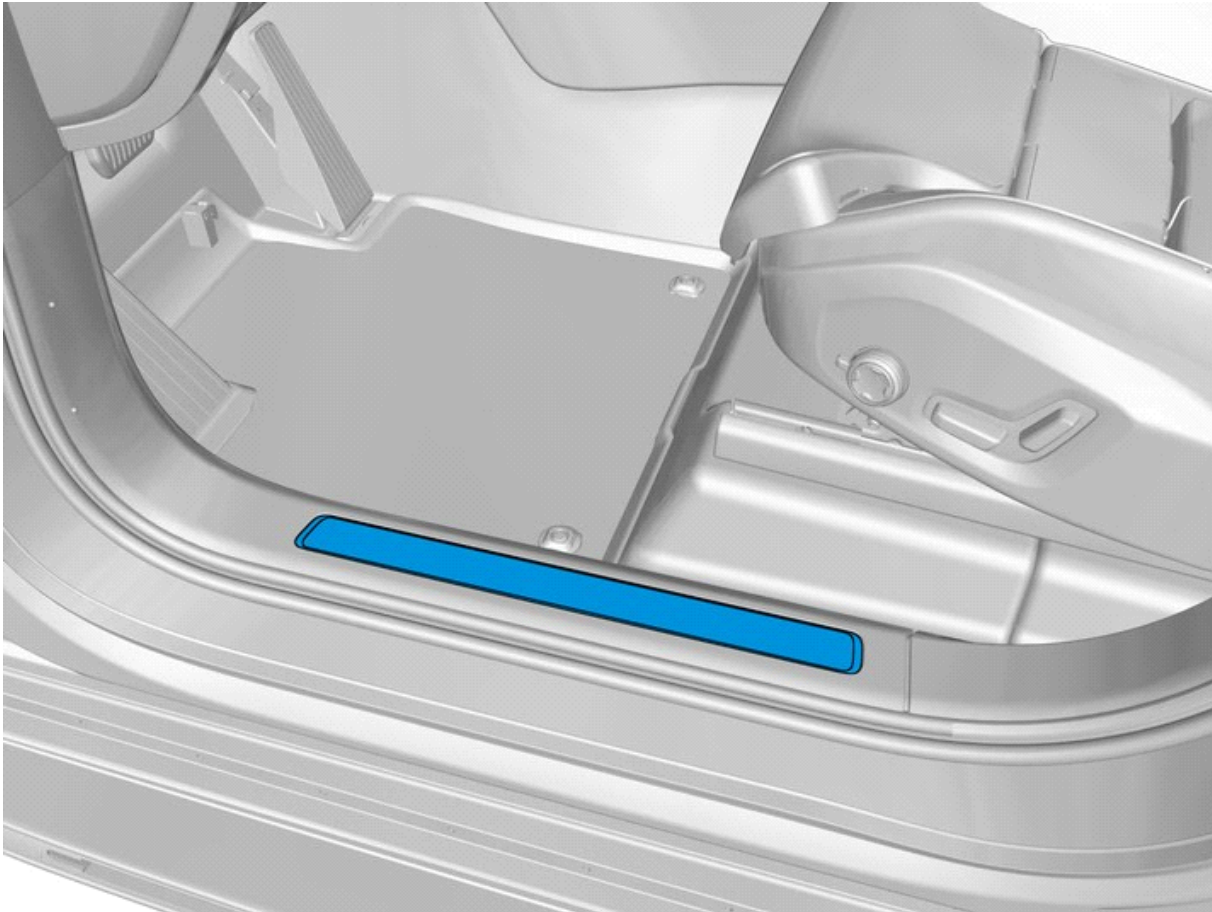

IMG-406596



# Installation instructions, accessories

Volvo Car Corporation Gothenburg, Sweden

## Equipment

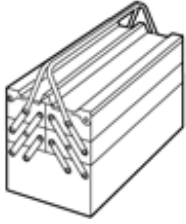

IMG-345497



IMG-239667

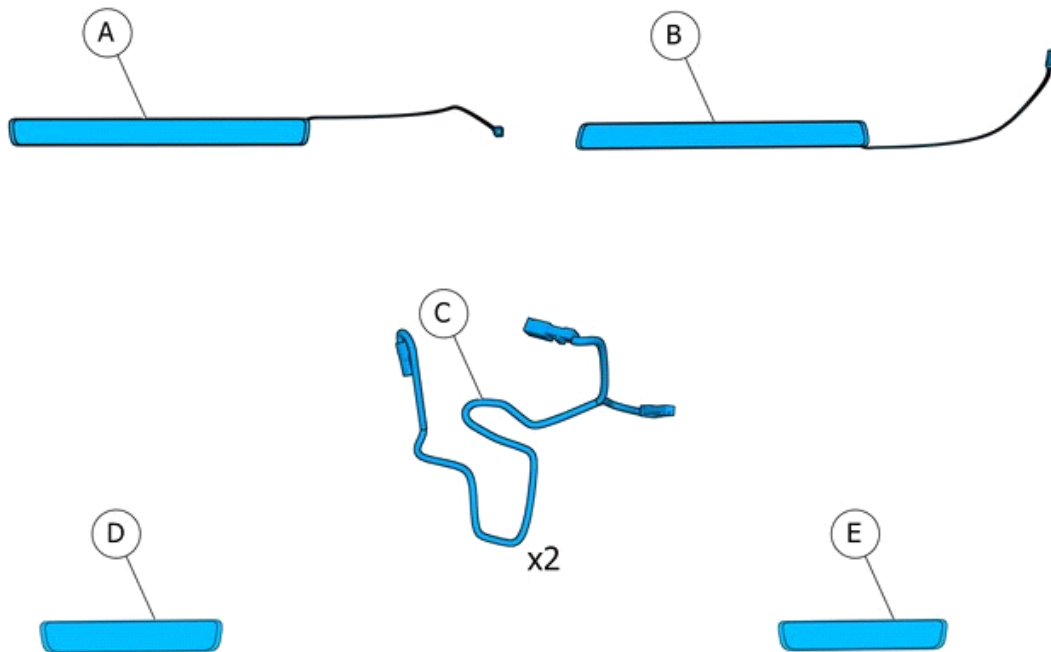

IMG-406595



# Installation instructions, accessories

Volvo Car Corporation Gothenburg, Sweden

## Information

1

Read through all of the instructions before starting installation.

Notifications and warning texts are for your safety and to minimise the risk of something breaking during installation.

Ensure that all tools stated in the instructions are available before starting installation.

Certain steps in the instructions are only presented in the form of images. Explanatory text is also given for more complicated steps.

In the event of any problems with the instructions or the accessory, contact your local Volvo dealer.

## Color symbols

2

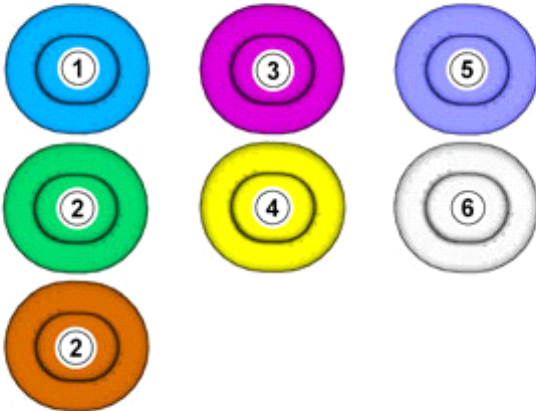

IMG-363036

### Note!

This colour chart displays (in colour print and electronic version) the importance of the different colours used in the images of the method steps.

1. Used for focused component, the component with which you will do something.
2. Used as extra colors when you need to show or differentiate additional parts.
3. Used for attachments that are to be removed/installed. May be screws, clips, connectors, etc.
4. Used when the component is not fully removed from the vehicle but only hung to the side.
5. Used for standard tools and special tools.
6. Used as background color for vehicle components.

## Removal



# Installation instructions, accessories

Volvo Car Corporation Gothenburg, Sweden

3

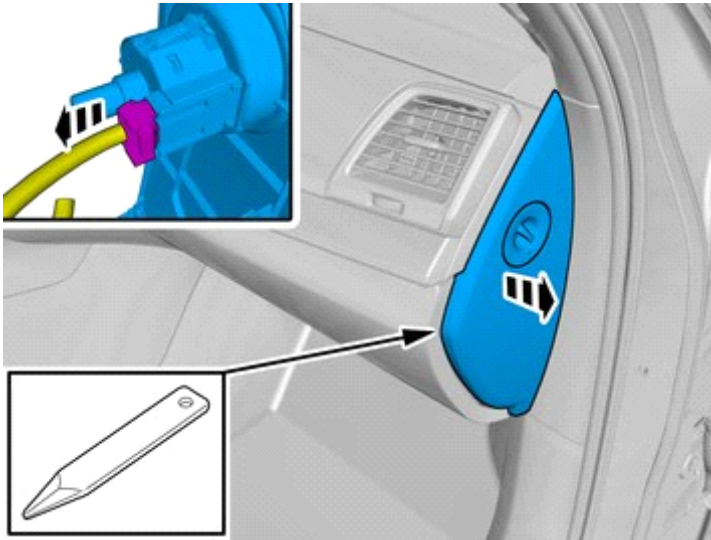

IMG-390109

Remove the panel.

Disconnect the connector, if applicable.

Repeat on the other side.

4

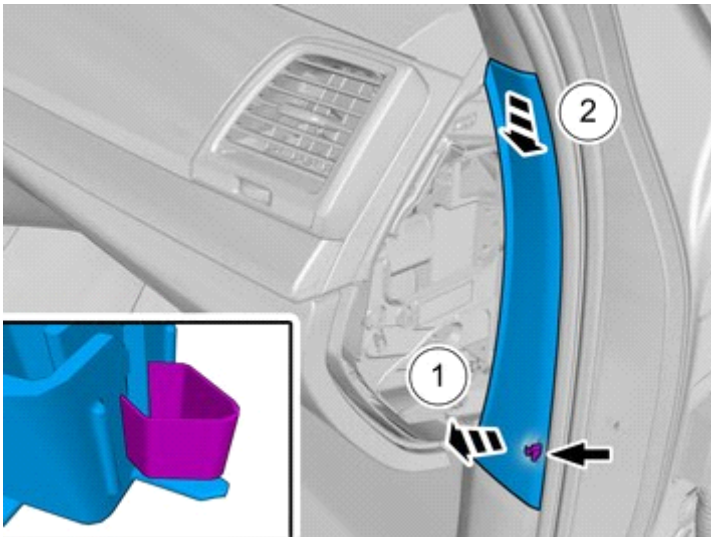

IMG-390116

Remove the panel.

Repeat on the other side.

5

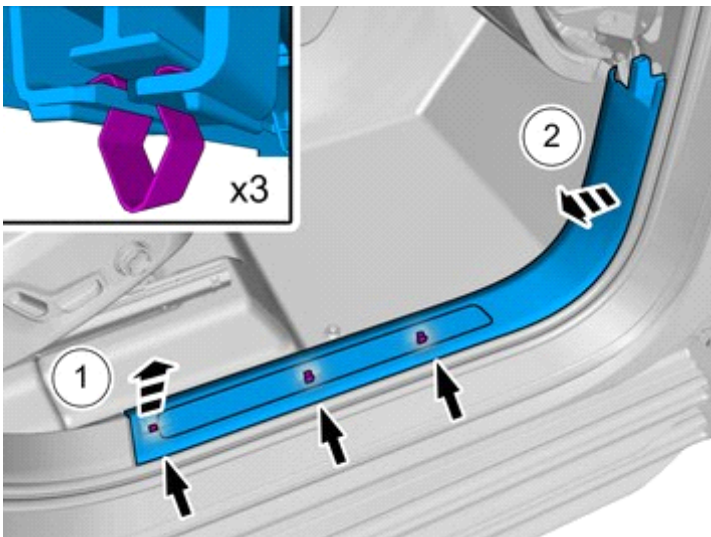

IMG-390106

Remove the panel.

Repeat on the other side.



# Installation instructions, accessories

Volvo Car Corporation Gothenburg, Sweden

6

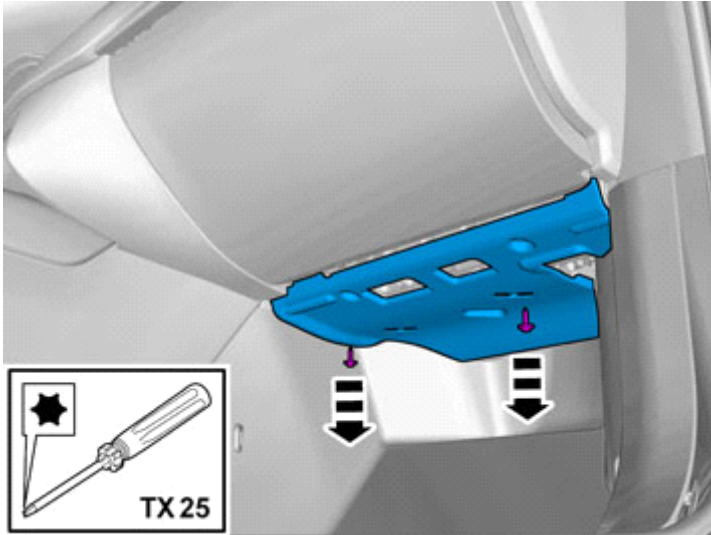

IMG-383237

Remove the screws.

Remove the panel.

7

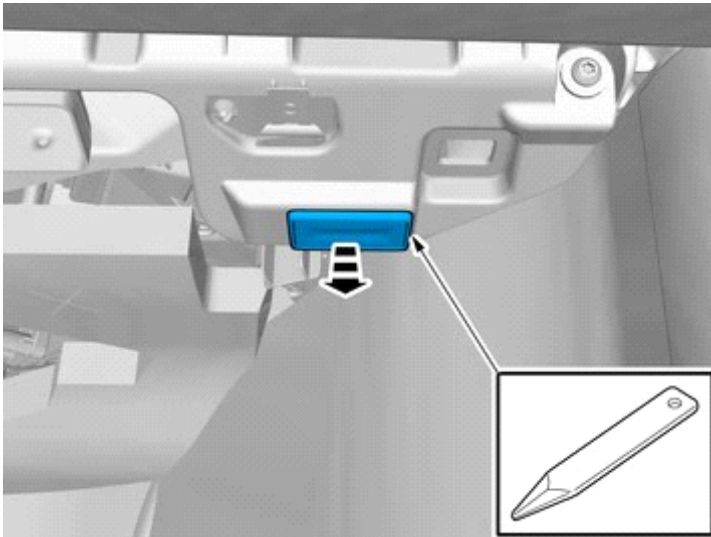

IMG-406626

Remove the marked part.

8

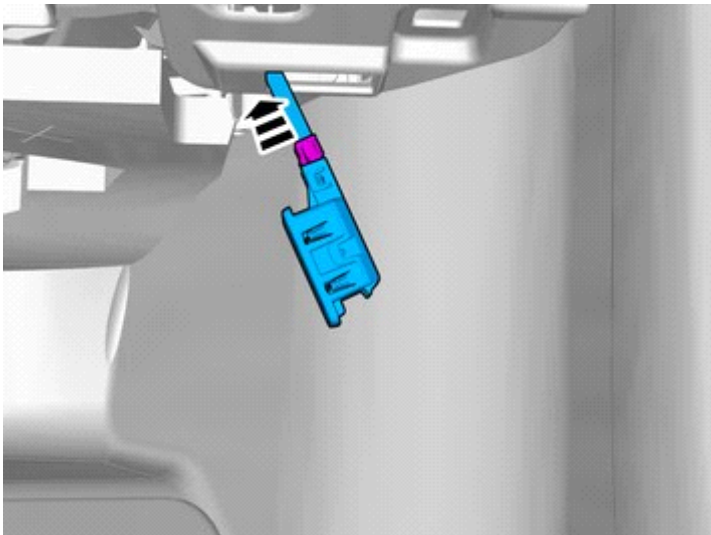

IMG-406628

Disconnect the connector.



# Installation instructions, accessories

Volvo Car Corporation Gothenburg, Sweden

9

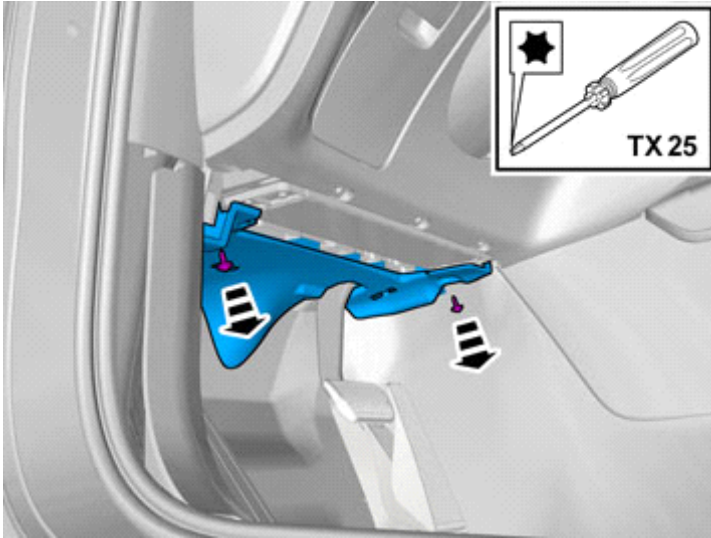

IMG-383314

Remove the screws.

Remove the panel.

10

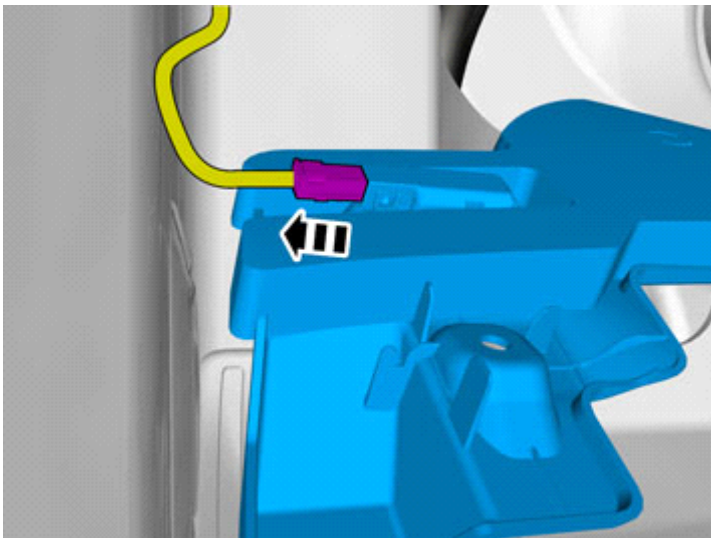

IMG-383315

Disconnect the connector.





# Installation instructions, accessories

Volvo Car Corporation Gothenburg, Sweden

11

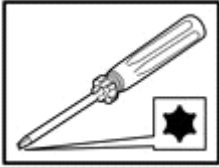

Remove the screws.



IMG-406875

12

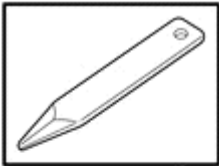

Remove the marked part.

The part is not to be reused.



IMG-406878

13

When removing on right-hand drive cars, perform the procedures on the opposite side and/or mirrored.

## Accessory installation



# Installation instructions, accessories

Volvo Car Corporation Gothenburg, Sweden

14

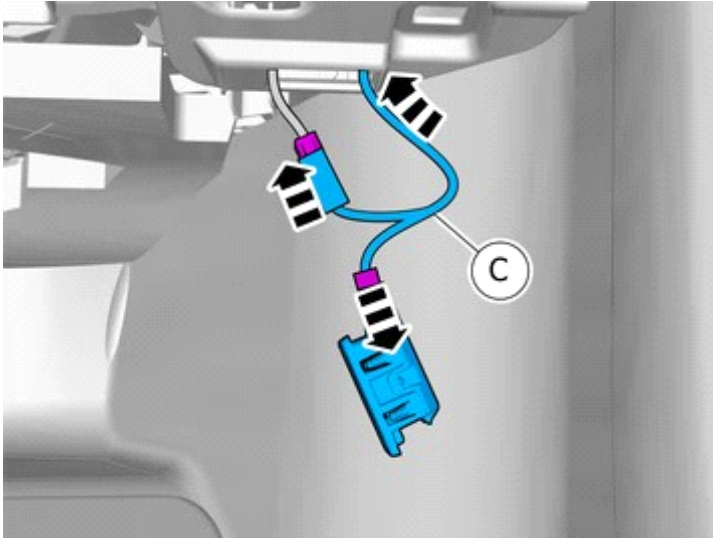

IMG-406925

Connect the connectors.

15

Install component that comes with the accessory kit.

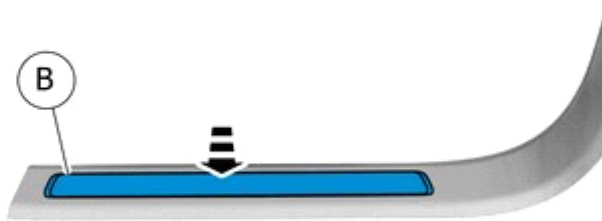

IMG-406879

16

Install the screws.

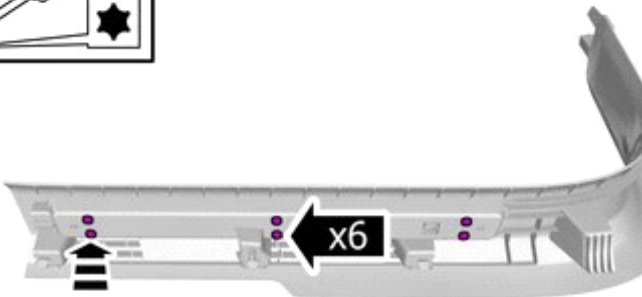
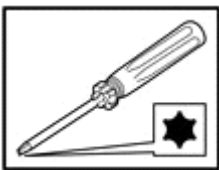

IMG-406877





# Installation instructions, accessories

Volvo Car Corporation Gothenburg, Sweden

17

Install the connector to its attachment.



IMG-406885

18

Connect the connector.

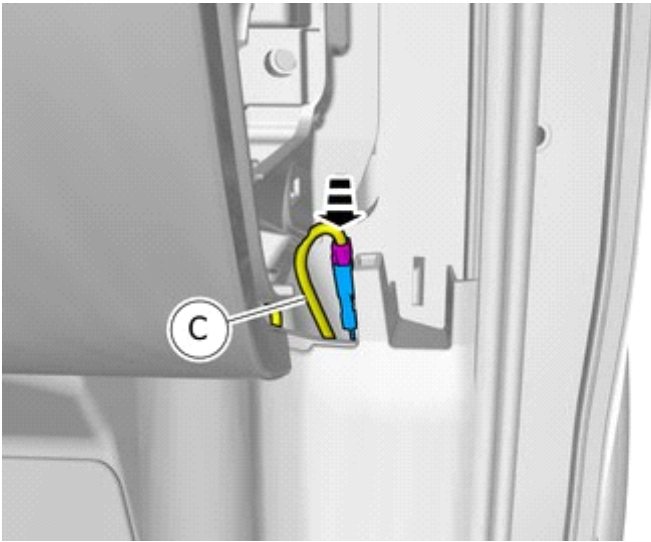

IMG-406926

19

Repeat the steps when installing accessories on opposite side.

Reinstall the removed parts in reverse order.

**Removal**



# Installation instructions, accessories

Volvo Car Corporation Gothenburg, Sweden

20

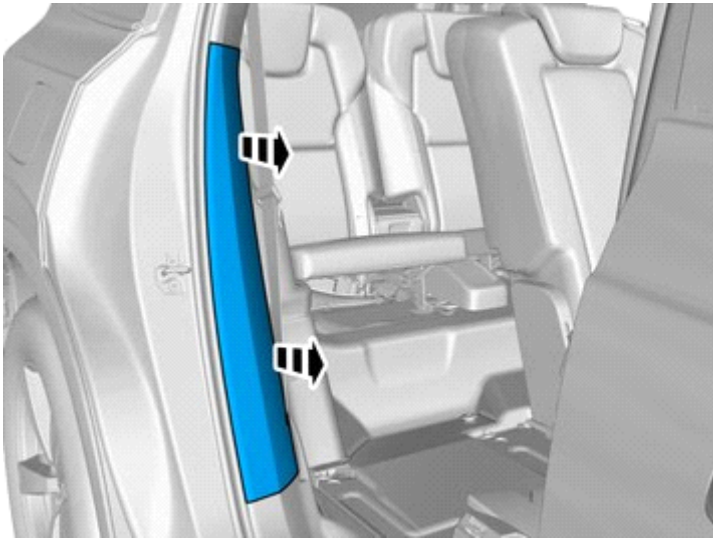

IMG-404384

Remove the panel.

21

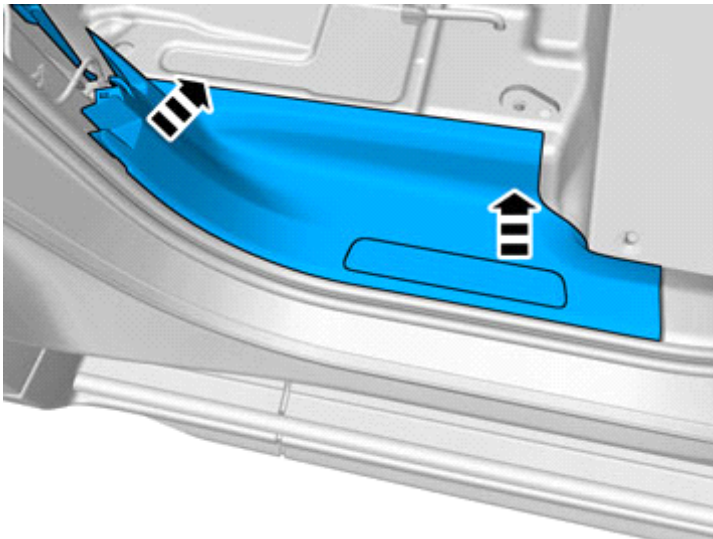

IMG-383234

Remove the panel.

22

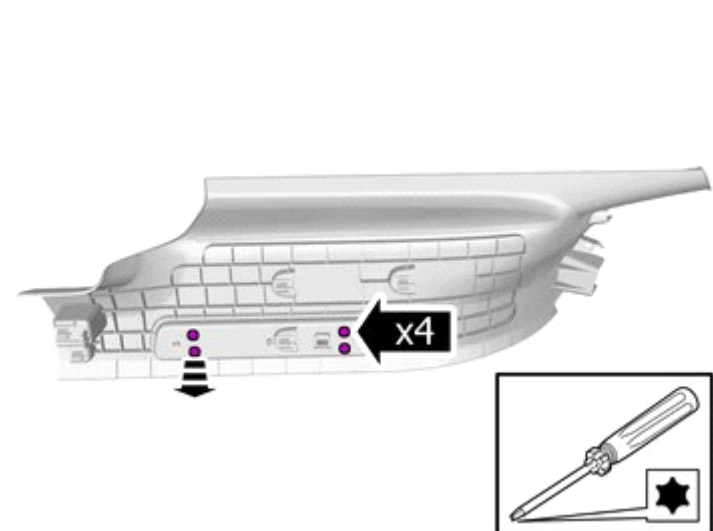

IMG-406635

Remove the screws.

The part is to be reused.



# Installation instructions, accessories

Volvo Car Corporation Gothenburg, Sweden

23

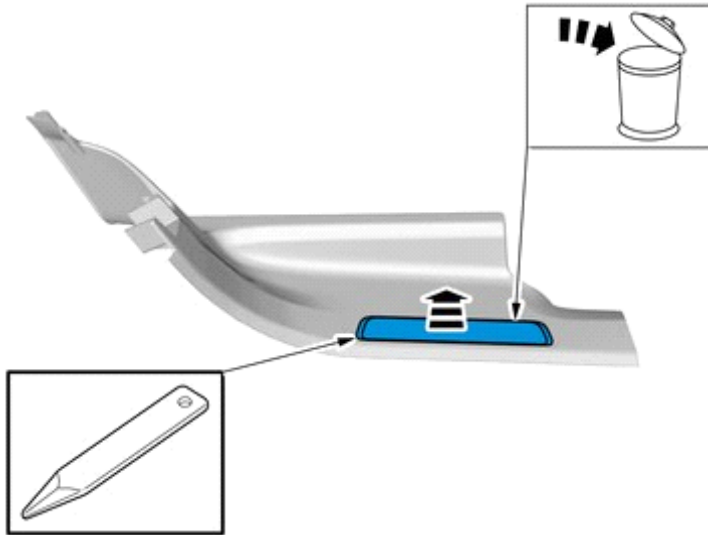

IMG-406637

Remove the marked part.

The part is not to be reused.

24

Repeat the steps when removing on opposite side.

## Accessory installation

25

Install component that comes with the accessory kit.



IMG-406638



# Installation instructions, accessories

Volvo Car Corporation Gothenburg, Sweden

26

Install the screws.

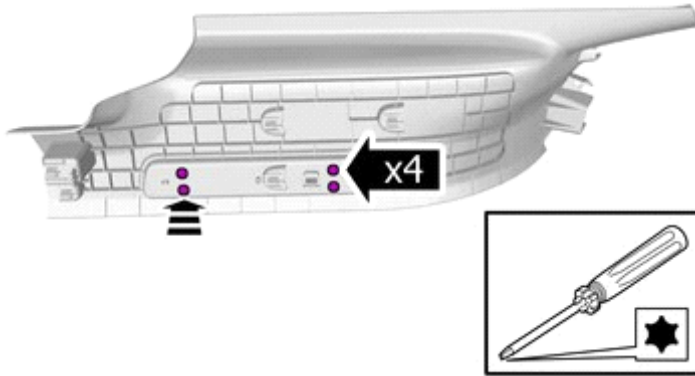

IMG-406636

27

Repeat the steps when installing on opposite side.

Reinstall the removed parts in reverse order.